

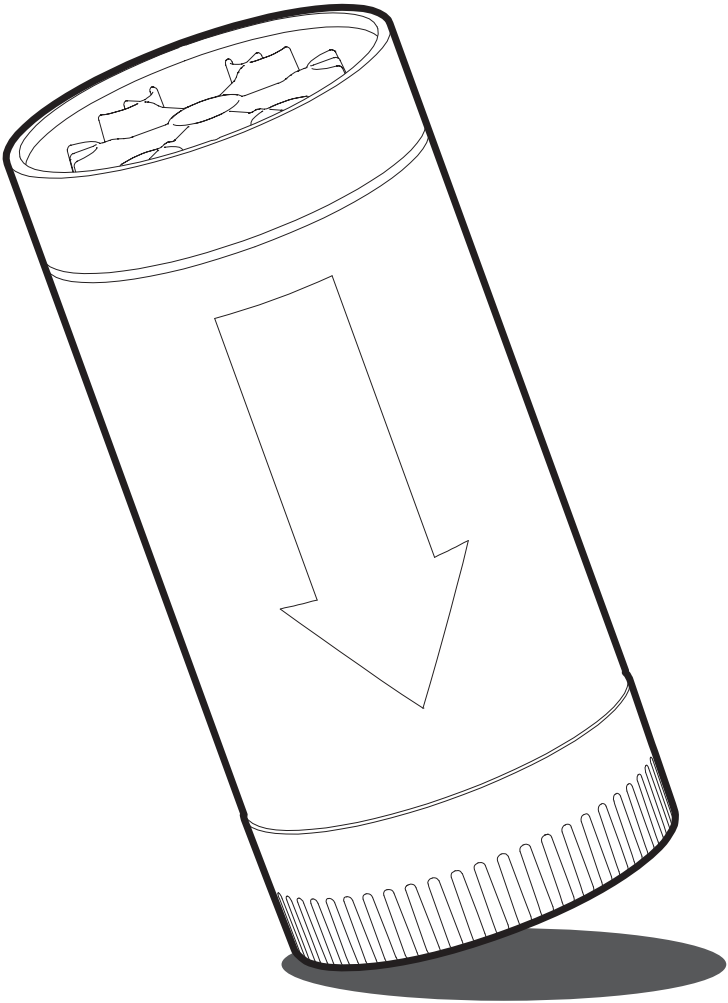

# SAUCE GUN BOTTLE



[www.ffoinnovations.com](http://www.ffoinnovations.com)



WASH ALL PARTS IN  
HOT, SOAPY WATER  
BEFORE FIRST USE

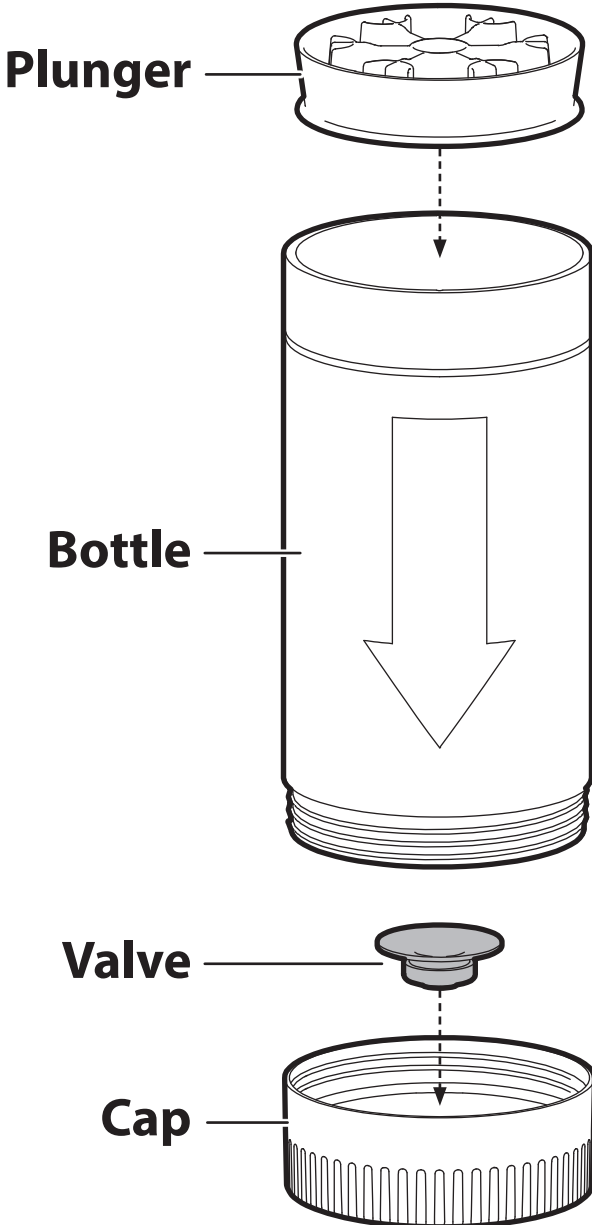

# A. PREPARATION AND FILLING

## 1. Inspect Valve

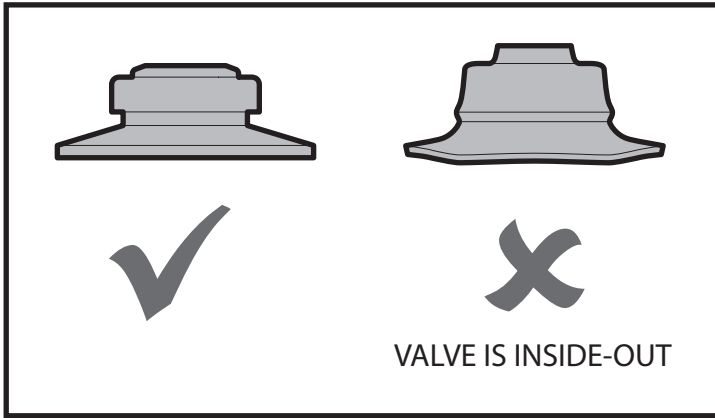

## 2. Place **Valve** into **Cap**, screw **Cap** onto **Bottle**

## 3. Fill bottle up to fill line.

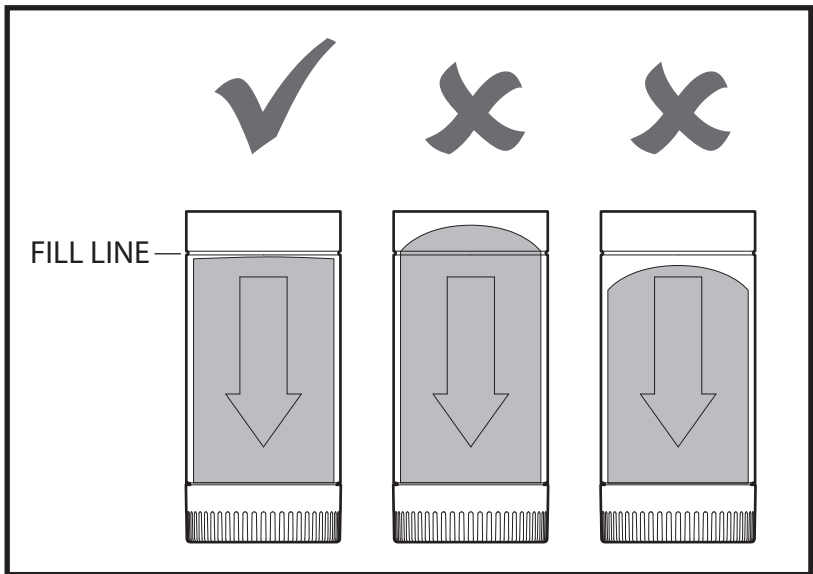

## 4. Press **Plunger**, flat side down, into bottle

## 5. Load bottle into sauce gun

## B. DISASSEMBLY FOR CLEANING



Before removing bottle from sauce gun, squeeze trigger and ensure that plunger is completely at bottom

1. Remove bottle from sauce gun, unscrew **Cap**, remove **Valve**
2. Use fingertip to remove **Plunger**

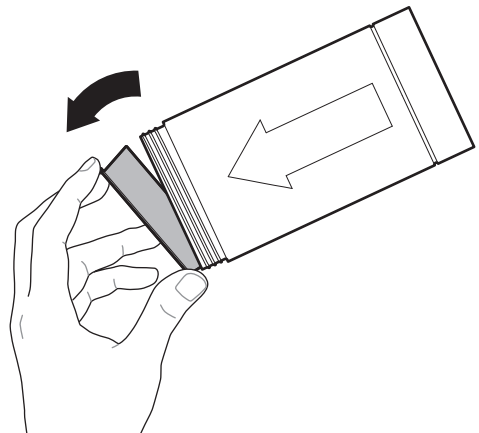
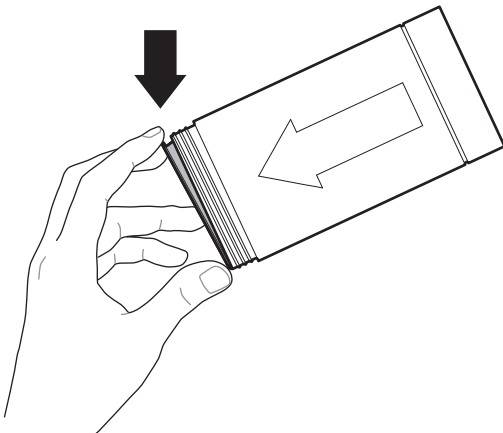
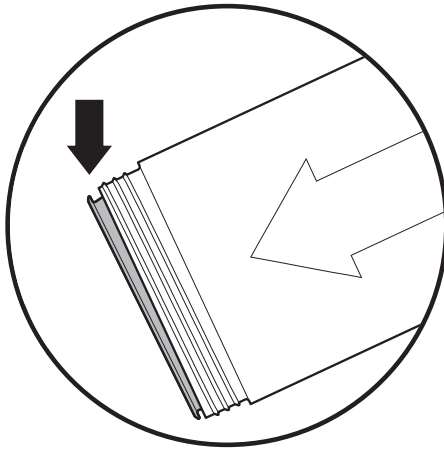

Note: Dispensed portions using Sauce Gun Bottle are about 10% less than dispensed portions from paperboard sauce tubes, a difference of about one droplet of sauce